

Model NO.	LCCS-040■342	Model Name	LED POWER SUPPLY
Part NO.		SIZE	95mm*70mm*32mm



FEATURES

- ◆ Suitable for Hi-Power LED Lighting Applications.
- ◆ Universal AC Input /Full range
- ◆ DC Output with Constant Current
- ◆ Safety : TUV / CB
- ◆ EMC :CE
- ◆ Compliant with IP67 (Waterproof)
- ◆ MTBF: 100,000 hrs / 25°C
- ◆ High Reliability
- ◆ Power Factor : >0.95@115VAC / >0.9@230VAC

Electrical Specifications @25°C

Input	Voltage range	90 ~ 264VAC
	Frequency range	47 / 63Hz
	Efficiency (Typ.)	80 %
	AC current	100Vac<0.5A ; 240Vac<0.3A
	Inrush current	50A / 230VAC cold start
	Leakage current	0.7mA / 264VAC / 50Hz
Function	Protection	Overload / Short circuit / Over voltage / Over temp.
Environment	Operating ambient Temp.	-20°C ~+60°C
	Operating relative Hum.	10%~+90%
	Storage ambient Temp.	-40°C ~+80°C
	Storage relative Hum.	10%~+95%
Others	MTBF	100,000 hrs / 25°C
	Safety & EMC	EN 61347-2-13 / CB / EN 55015
	RoHS	YES
	Dimension (mm) L*W*H	90 * 70 * 32mm

LCCS-040■342

Model No.	DC Output Voltage	DC Output Current	Watt Max.	Remark
LCCS-040■342	9 - 12 V	3.4 A ± 5%	40.8 W	

*Reference

Model NO.	LCCS-040■342	Model Name	LED POWER SUPPLY
Part NO.		SIZE	95mm*70mm*32mm

DIMENSIONS [mm]

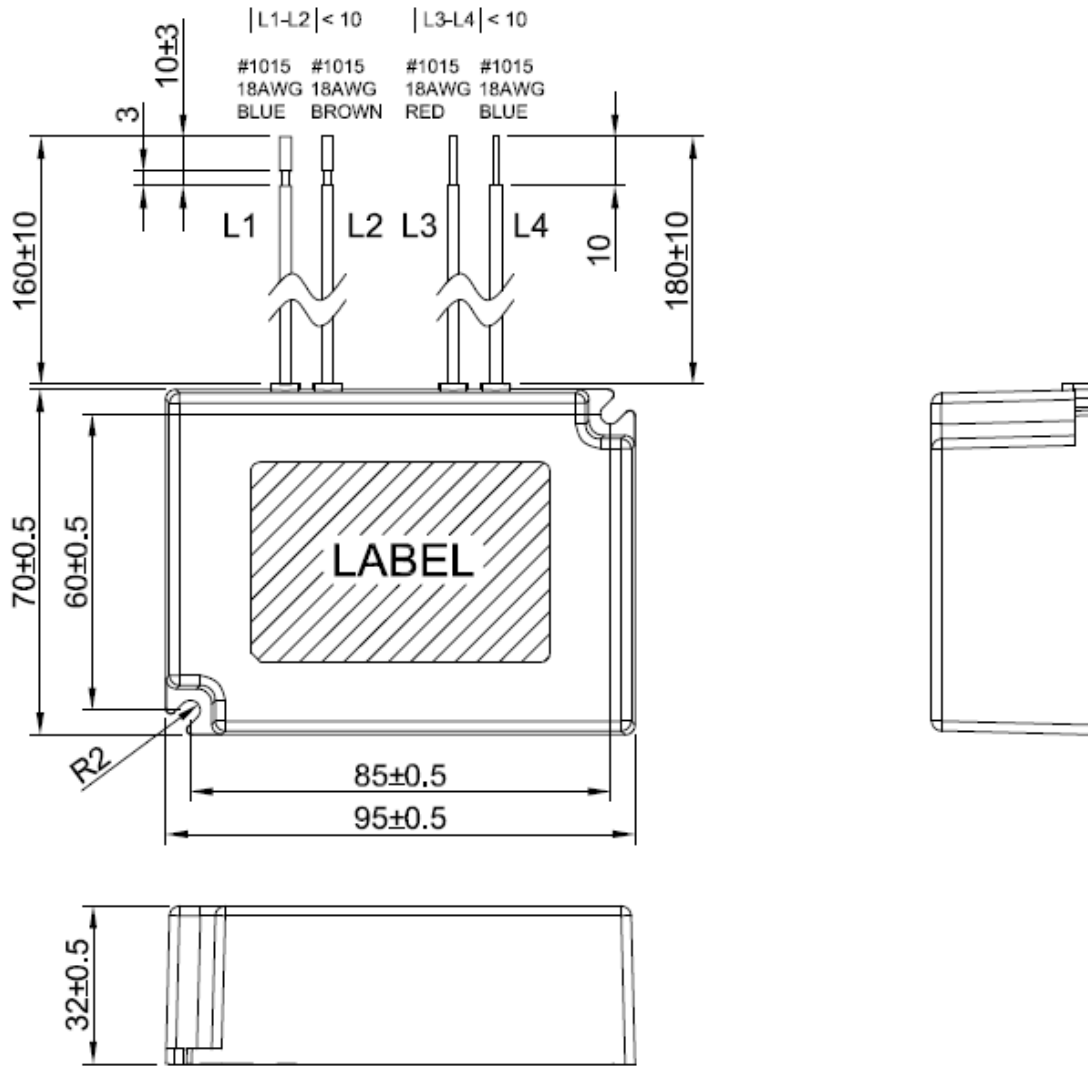

Unit: mm

*Reference